



Serrature per infissi e serrande
Locks for fixtures and rolling shutters

100% MADE IN ITALY



IT01.IT/445.0 0.V

CHI SIAMO

Cipierre opera nel settore della produzione di serrature di sicurezza ed accessori per serramenti blindati.

Si contraddistingue per un grande dinamismo che ha permesso un'ininterrotta crescita nei suoi oltre 30 anni di vita.

Grazie al proprio know-how, come testimonia la commercializzazione internazionale di soluzioni innovative, ha fatto registrare un aumento esponenziale del proprio fatturato.

LA NOSTRA STORIA

La storia di Cipierre inizia nel 1978, in provincia di Roma (Guidonia) come fornitrice di lavorazioni meccaniche specializzate.

Dal 1984 decide di sviluppare il settore relativo alla sicurezza, con la progettazione e la realizzazione di accessori per porte blindate.

Negli anni successivi l'Azienda, che continua la propria attività anche per conto terzi, diventa un punto di riferimento nazionale e internazionale del settore con un proprio brand.

La costante crescita, permette nel 2016 di aprire una seconda sede a Tivoli Terme (RM), dove Cipierre trasferisce le linee di stampaggio e lavorazione della lamiera, tutte le linee di assemblaggio oltre che le direzioni tecniche operative e commerciali.

IL NOSTRO FUTURO

Il processo di crescita che Cipierre ha intrapreso oltre 30 anni fa continua il suo corso, con la volontà di farsi trovare sempre pronta e all'altezza delle sempre più esigenti e tecnologicamente avanzate richieste del mercato.

La qualità e la trasparenza di Cipierre viene garantita dalla certificazione "100% Made in Italy", rilasciata dall'Istituto per la Tutela dei Produttori Italiani.

Cipierre realizza i suoi prodotti in Italia utilizzando disegno e progettazione esclusivi e servendosi di materiali di qualità e di prima scelta.

Il Sistema di Certificazione "IT01-100% Qualità Originale Italiana" è una garanzia ulteriore che Cipierre offre ai suoi clienti, nazionali e internazionali.

WHO'S CIPIERRE

Cipierre is a manufacturing Company working in the production of high security locks and accessories for armoured doors.

Its great dynamism allowed a continuous growth in its more than 30 years of activity.

Thanks to its know-how, as evidenced by the excellent international appreciations of our innovative solutions for security, has seen an exponential increase of its turnover.

OUR HISTORY

The Company begins in 1978, as a sub-supplier of specialized machining processing in a plant located near to Rome (Guidonia).

Since 1984 Cipierre decided to develop the field of the security, with own design and manufacturing implementation of accessories for doors.

In the following years the Company continues its activities in sub-supplying, and develops its own brand, becoming a national and international reference for special security products.

The continued growth, in 2016 allows to open a new facility in Tivoli Terme (RM), where Cipierre moves the sheet and strip manufacturing lines, all the assembly departments and operative, commercial and technical directions.

OUR FUTURE

The process of growth that has taken Cipierre 30 years ago, is running thanks to the Company strategy aimed to satisfy the market requests and to propose always more technologically advanced solutions.

The quality and traceability of Cipierre products is guaranteed by the certification "100% Made in Italy", issued by the Institute for the Protection of Italian Manufacturers.

Cipierre manufactures its products in Italy using exclusive own design and using first choice quality materials.

The Certification System "IT01-100% Original Italian Quality" is a further guarantee that Cipierre offers to its customers.

Serratura doppia mappa ad infilare

Double bit key mortise lock

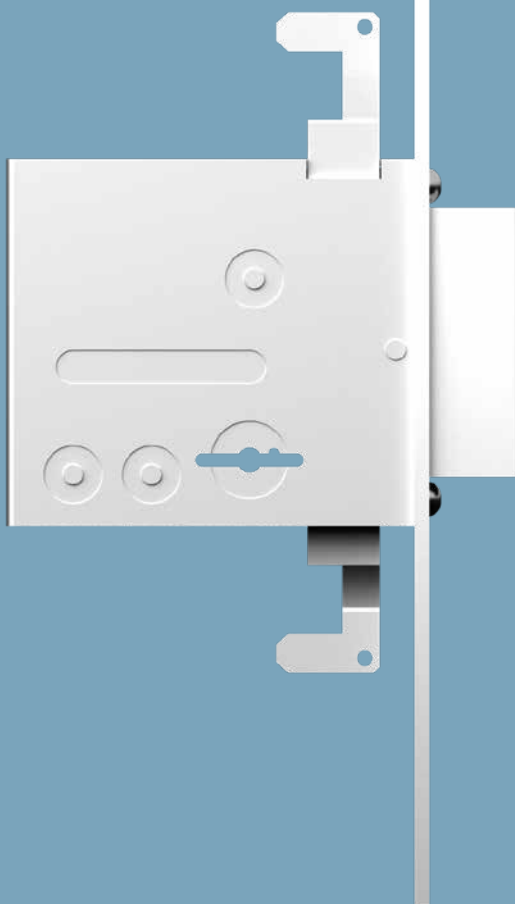

- Modello laterale o triplice
- Versione 2 e 4 mandate
- Entrate 30 40 50 60 70 mm secondo le versioni
- Disponibile con chiavi Ka
- In dotazione:
 - 2 chiavi in ottone
 - 1 bocchetta coprilavorazione
 - 2 raccordi filettati per aste (versione 3000)
 - 2 spine elastiche (versione 3000)
- Single point or 3 point locking version
- 2 or 4 throws version
- 30 40 50 60 70 mm backset
- Ka key available
- Supplied with:
 - 2 brass keys
 - 1 key guide washer
 - 2 rod threaded connectors (3000 version)
 - 2 spring pins (3000 version)

1000

Codice Code	Entrata E Backset E	Mandate Throws	Corsa C Stroke C	Profondità P Depth P	Confezione Packaging
1230	30	2	18	33,5	25
1240	40	2	18	33,5	25
1250	50	2	18	33,5	25
1450	50	4	36	50	25
1460	60	4	36	50	25
1470	70	4	36	50	25

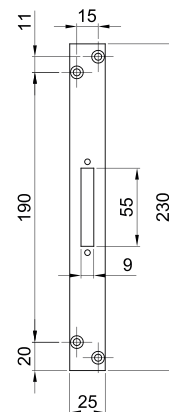
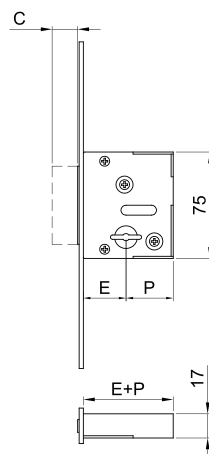

3000

Codice Code	Entrata E Backset E	Mandate Throws	Corsa catenacci C Bar stroke C	Corsa rinvii X Bar stroke X	Profondità P Depth P	Confezione Packaging
3250	50	2	18	15	33,5	25
3260	60	2	18	15	33,5	25
3460	60	4	36	20	50	25
3470	70	4	36	20	50	25

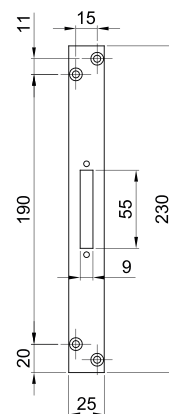
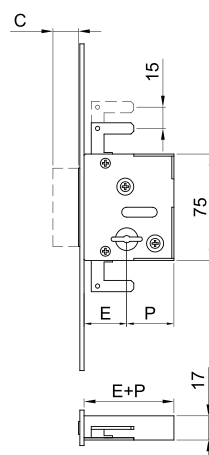

Serratura doppia mappa per serranda

Double bit key for rolling shutter

- Modello laterale o centrale
- Disponibile versione per serranda basculante
- Disponibile con chiavi Ka
- In dotazione:
 - 2 chiavi in ottone
 - 2 perni di fissaggio (versione centrale)
- Side and central lock version
- Up and over door lock available
- Ka key available
- Supplied with:
 - 2 brass keys
 - 2 fixing pins (central version)

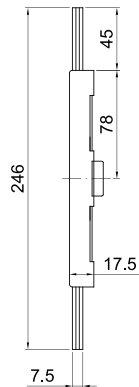
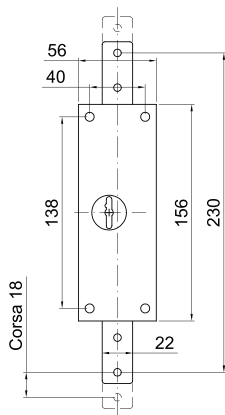
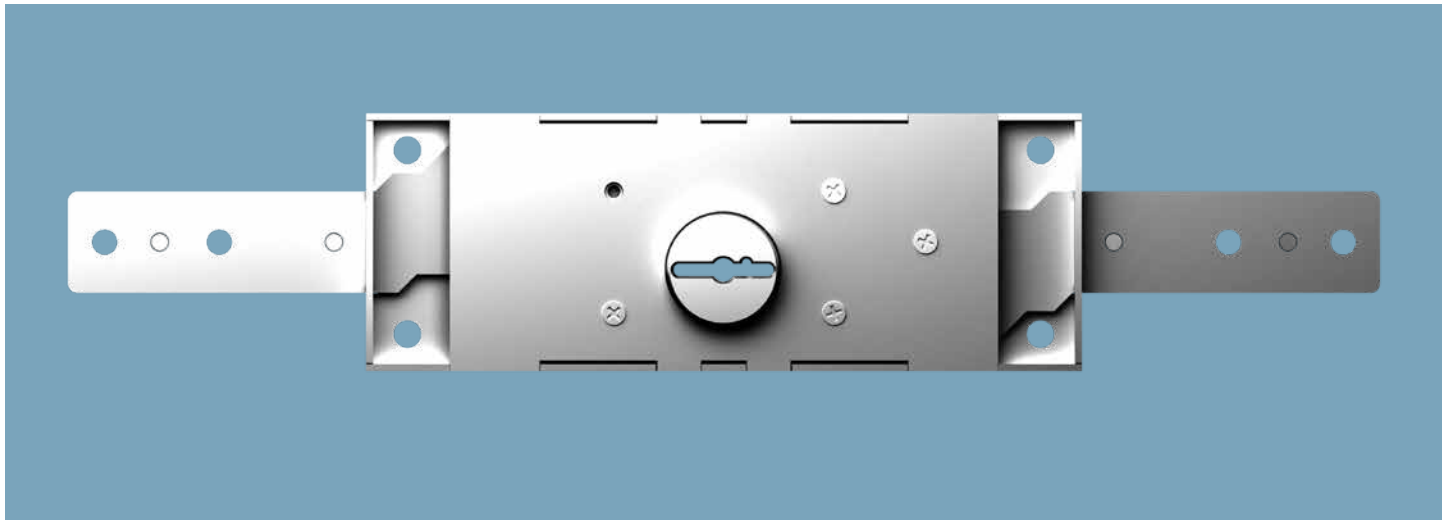

3600/C

Serratura Centrale
Central Lock

Codice Code	Finitura Finishing	Confezione Packaging
3600/C	ZN	20

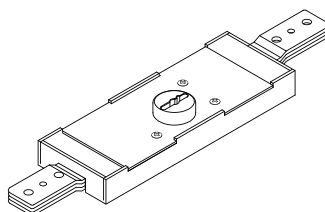
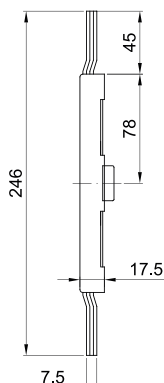
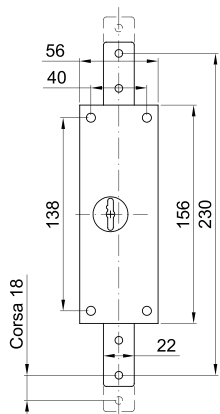

3600/C/Z

Serratura Centrale zancata
Bended central Lock

Codice Code	Finitura Finishing	Confezione Packaging
3600/C/Z	ZN	20

Serratura doppia mappa per serranda

Double bit key for rolling shutter

3600/L

Serratura laterale Side Lock

Codice Code	Mano Hand	Finitura Finishing	Confezione Packaging
3600/L/D	DX	ZN	20
3600/L/S	SX	ZN	20
3600/L/CP	Coppia Pair	ZN	10

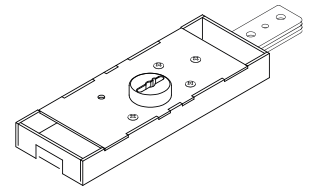
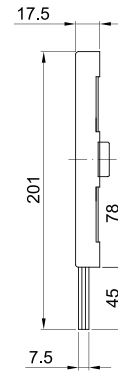
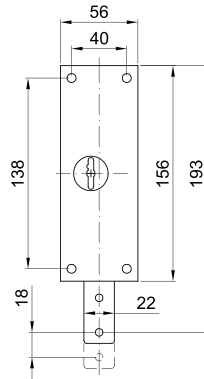

3600/L/Z

Serratura laterale zancata Bended side Lock

Codice Code	Mano Hand	Finitura Finishing	Confezione Packaging
3600/L/Z/D	DX	ZN	20
3600/L/Z/S	SX	ZN	20
3600/L/Z/CP	Coppia Pair	ZN	10

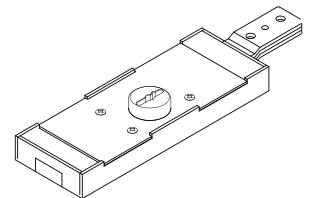
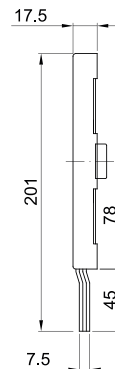
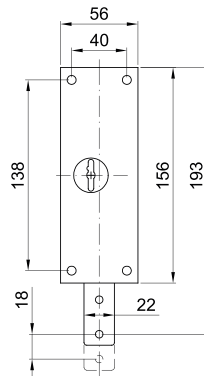

3600/L/B

Serratura per basculante Lock for up and over doors

Codice Code	Finitura Finishing	Confezione Packaging
3600/L/B	ZN	20

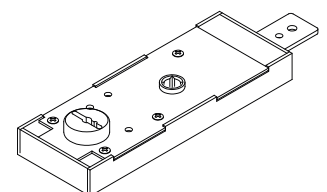
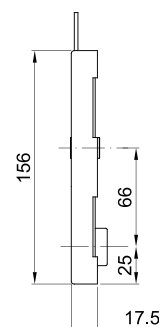
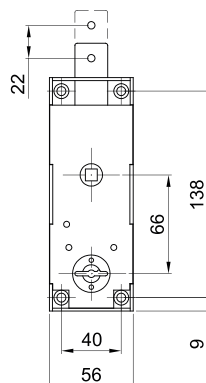

Contropiastre e accessori

Striking plates and accessories

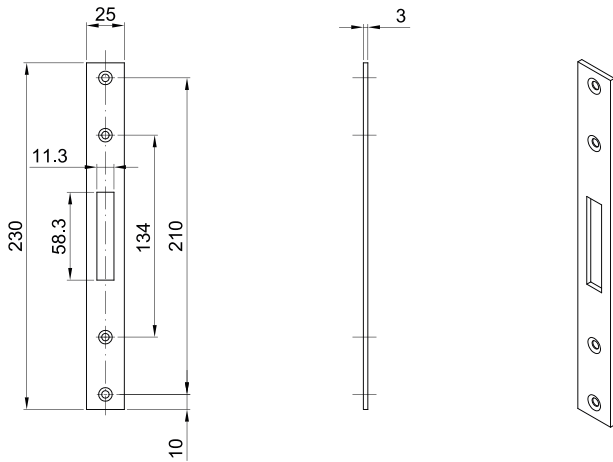

1100

Contropiastra per serie 1000 e 3000
Striking plate for 1000 - 3000 series

Codice Code	Finitura Finishing	Confezione Packaging
1100	ZN	10

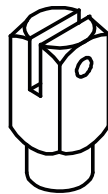
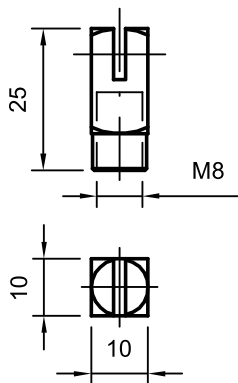

1110

Boccola filettata M8
M8 threaded bush

Codice Code	Finitura Finishing	Confezione Packaging
1110	ZN	100

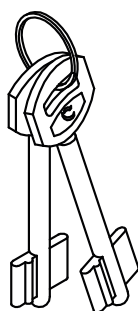

1000

Chiave doppia mappa grezza
Double bit-key blank

Codice Code	Finitura Finishing	Confezione Packaging
1000	NK	100

Aste “cancelletto”

Roads for gates

604

Coppia aste “cancelletto”

Pair of rods for gates

Codice Code	Fissaggio Fixing	Finitura Finishing	Ø Perno X Ø Pin X	Confezione Packaging
604/10/Z	Asola Hole	ZN	10	25
604/12/Z	Asola Hole	ZN	12	25
604/14/Z	Asola Hole	ZN	14	25

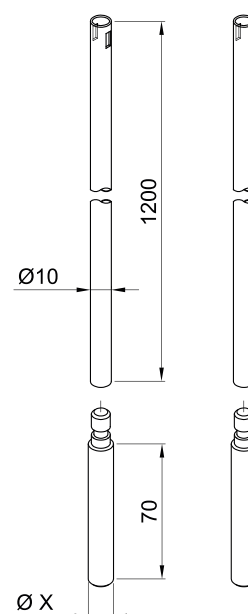

605

Coppia aste “cancelletto” Ø8mm

Pair of rods for gates Ø8mm

Codice Code	Fissaggio Fixing	Finitura Finishing	Ø Perno X Ø Pin X	Confezione Packaging
605/8/10/Z	grano M8 screw M8	ZN	10	25
605/8/12/Z	grano M8 screw M8	ZN	12	25
605/8/14/Z	grano M8 screw M8	ZN	14	25
605/8/10/G	grano M8 screw M8	NT	10	25
605/8/12/G	grano M8 screw M8	NT	12	25
605/8/14/G	grano M8 screw M8	NT	14	25

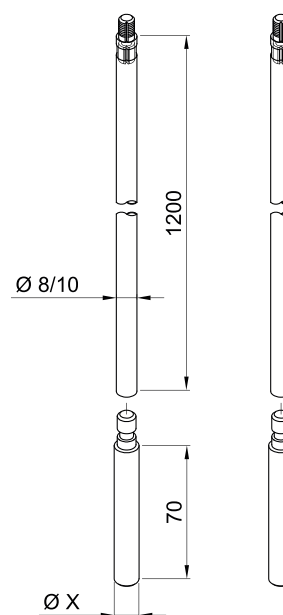

Coppia aste “cancelletto” Ø10mm

Pair of rods for gates Ø10mm

Codice Code	Fissaggio Fixing	Finitura Finishing	Ø Perno X Ø Pin X	Confezione Packaging
605/10/10/Z	grano M8 screw M8	ZN	10	25
605/10/12/Z	grano M8 screw M8	ZN	12	25
605/10/14/Z	grano M8 screw M8	ZN	14	25

Aste "cancelletto" Roads for gates

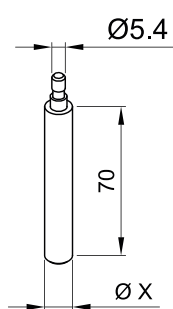
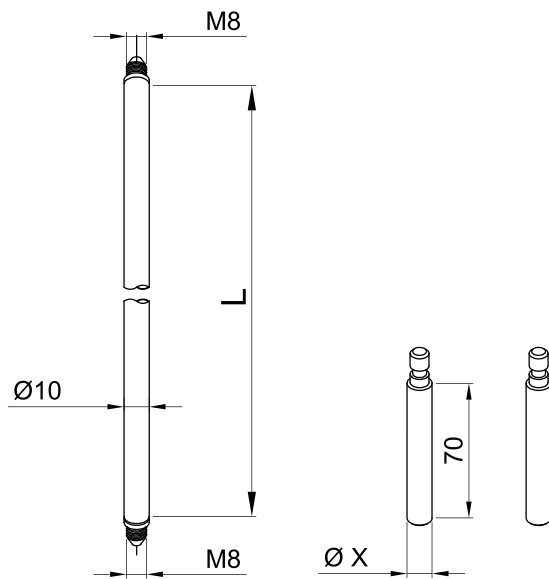

PER ASTE Ø8

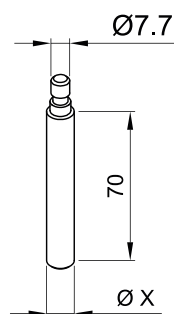

PER ASTE Ø10

608

Asta filettata due lati Ø10mm
Top down threaded Ø10mm rod

Codice Code	Fissaggio Fixing	Finitura Finishing	Ø Perno X Ø Pin X	Confezione Packaging
608/10/Z	grano M8 screw M8	ZN	10	50
608/12/Z	grano M8 screw M8	ZN	12	50
608/14/Z	grano M8 screw M8	ZN	14	50

Lunghezze L disponibili : 1000mm / 1200mm / 1500mm
Available lengths L : 1000mm / 1200mm / 1500mm

610 - 612 - 614

Perno terminale per aste "cancelletto" Ø8mm
Bolt for gate rods Ø8mm

Codice Code	Finitura Finishing	Ø Perno X Ø Pin X	Confezione Packaging
610/8/Z	ZN	10	100
612/8/Z	ZN	12	100
614/8/Z	ZN	14	100

Perno terminale per aste "cancelletto" Ø10mm
Bolt for gate rods Ø10mm

Codice Code	Finitura Finishing	Ø Perno X Ø Pin X	Confezione Packaging
610/10/Z	ZN	10	100
612/10/Z	ZN	12	100
614/10/Z	ZN	14	100

Note

Note

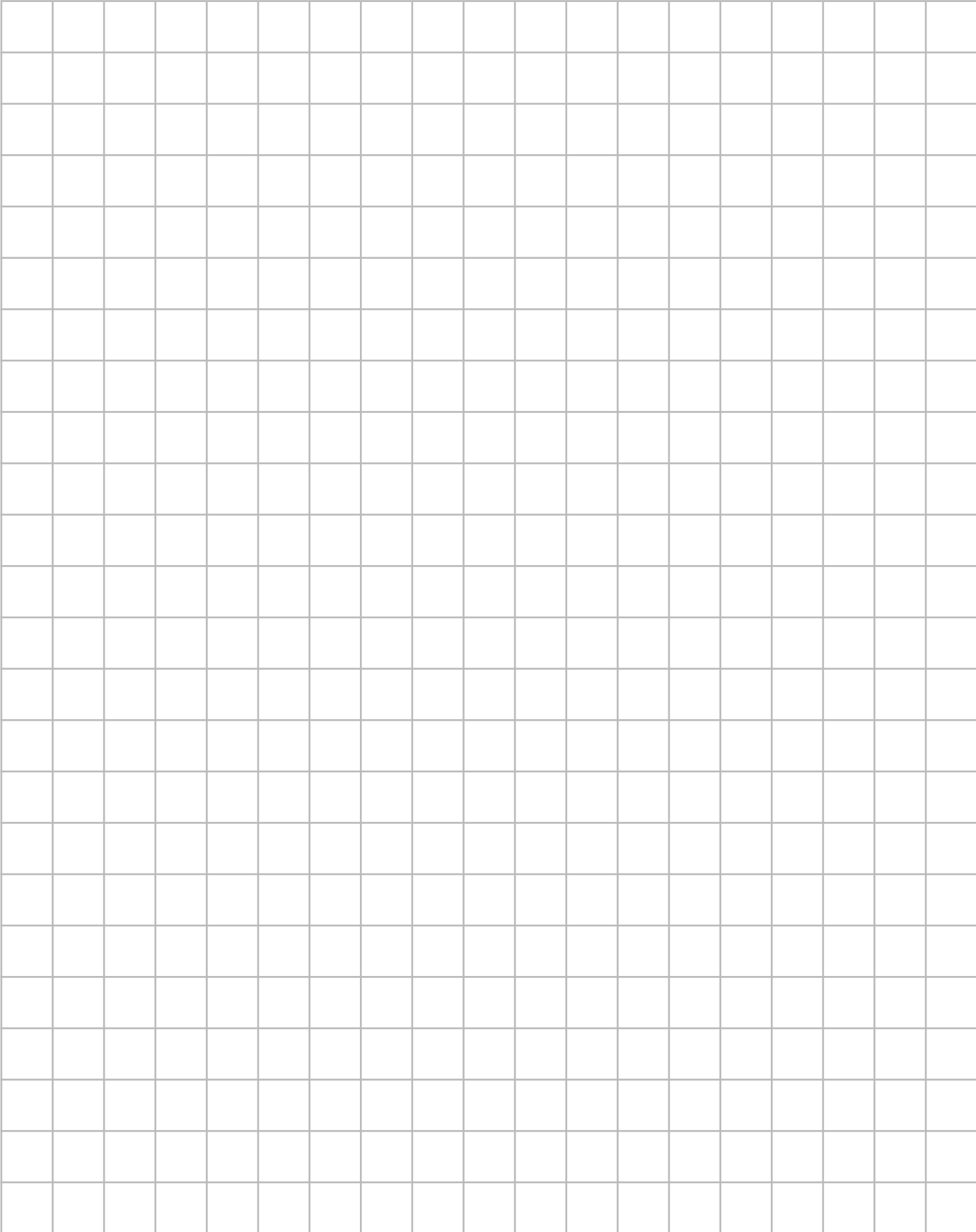

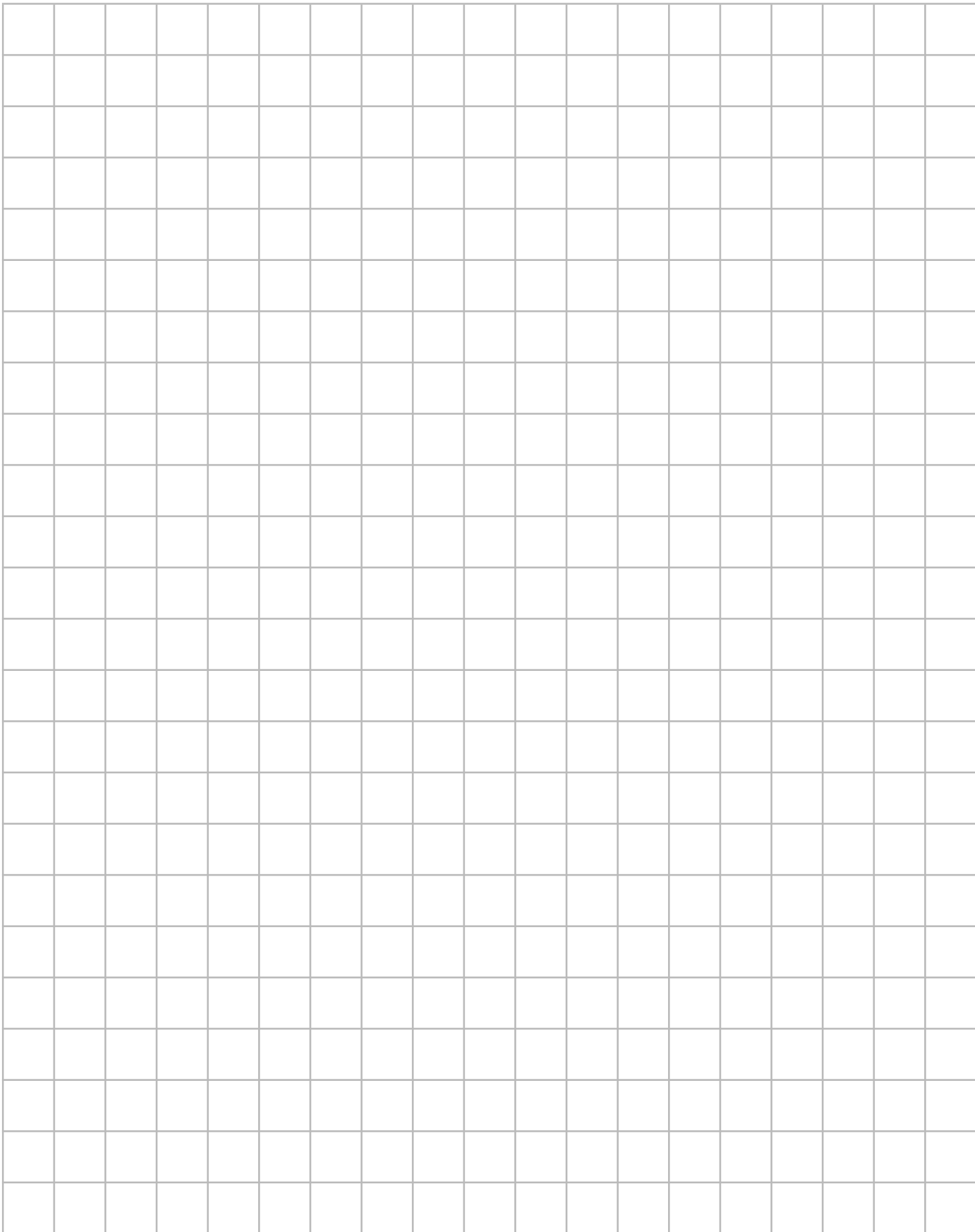

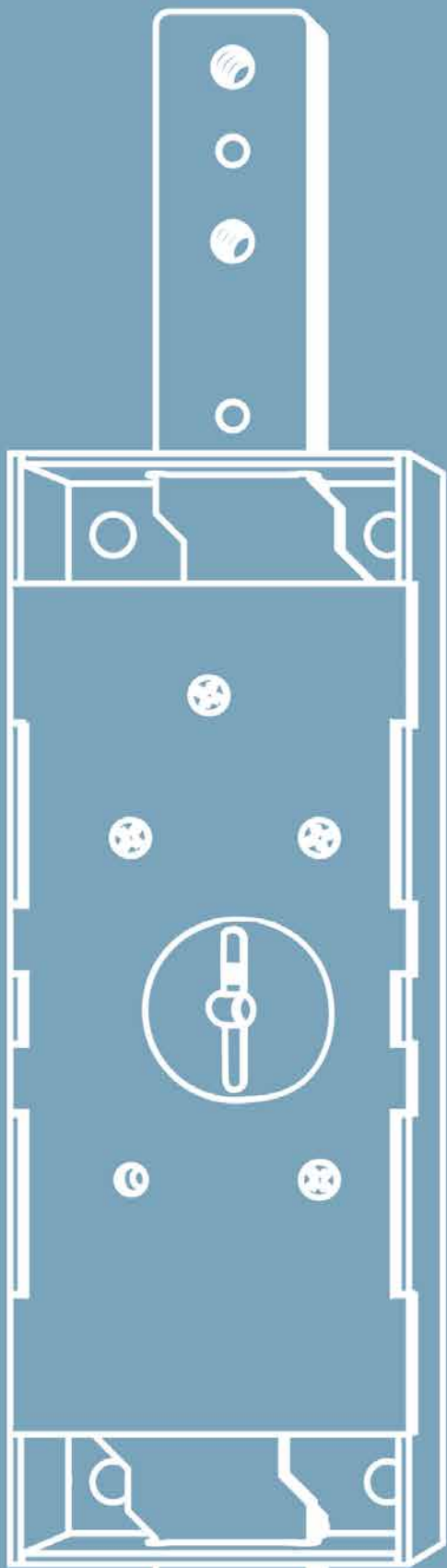

Cipierre S.r.l.

Sede operativa 1 Via Tazio Nuvolari, 12 - 00011 Tivoli Terme - Roma, Italy

Sede operativa 2 Via Luigi Einaudi, 3 - 00012 Guidonia Montecelio - Roma, Italy

Sede legale Via Massimi, 154 - 00136 Roma, Italy

Tel. +39 0774 35 55 90 +39 0774 37 86 35 - Fax +39 0774 37 99 24 - info@cipierre.com

WWW.CIPIERRE.COM

